

RDS™

Radially Divided Seals



- Minimum parts to assemble
- Patented assembled spring retainer
- External, visible, indicator of correct installation
- Balanced stationary design with large internal clearances
- Unique 'O' ring design

RDS™ — Radially Divided Seal

The RDS™ eliminates the need to remove or strip equipment for seal replacement. The unique design makes it the quickest to install two-part seal currently available in the market place.

Significant product development and dynamic testing were aimed at ensuring that the operating performance of the RDS™ seal would be predictable.

The RDS™ seal represents a significant advancement in separation technology and bridges the gap between pump packing and conventional mechanical seals.



Radially Divided Seal

The RDS™, radially divided seal, has eliminated one potential leak-path by producing the rotary member as a precision lapped two-part rotary seal. Leakage control on the RDS™ rotary, which has been lapped to the same standards as a normal rotary seal face, is potentially more predictable than faces used in other designs.

The RDS™ radially divided rotary has the secondary benefit of avoiding the need for additional sealing 'O' rings and gasket sealing devices.

Large Cross Section

Many RDS™, radially divided seals, will be used to replace stuffing box packing. Often the shaft or sleeve will be heavily scored by the packing, particularly on larger diameters.

A possible option might be to remove the sleeve entirely, or reduce the outside diameter of the sleeve or shaft to provide a good surface to seal the RDS™ on.

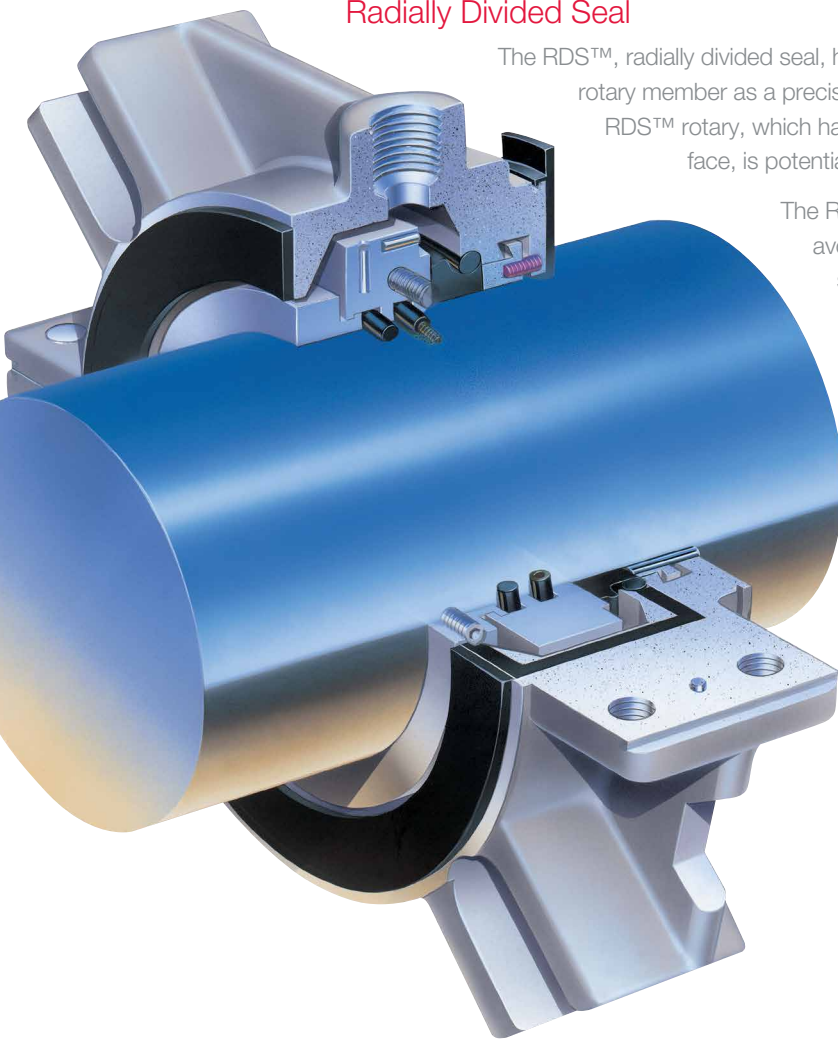

- Precision lapped rotary seal-face provides industry leading separation technology and predictable sealing
- External wear indicator assists preventative maintenance
- Hydraulically balanced seal-faces for reduced seal-face loading, maximizing seal life and allowing for vacuum service capability
- Minimum parts to assemble
- Self-aligning stationary face
- Unique 'O' ring design (for predictable easy joining and assembly)
- By design gland studs or socket screws do not add to the installed length
- Patented assembled spring retainer (springs cannot fall out)

RDS™ — Radially Divided Seal

All RDS™ seals are guaranteed not to fret the shaft or sleeve, following installation. This means that it might be practical to remove the shaft sleeve entirely, as long as it is not designed to set or position the impeller clearance.

With other designs, i.e. split seals, this option might not be available without manufacturing an adaptor plate, to seal the larger cross section that would result from reducing the shaft or sleeve outside diameter size.

Such an adaptor plate would have to be split, normally, with gaskets between the two adaptor halves. There would also have to be a split gasket sealing against the stuffing box face. Naturally, the more potential leakage paths the less chance of predictable trouble-free sealing.

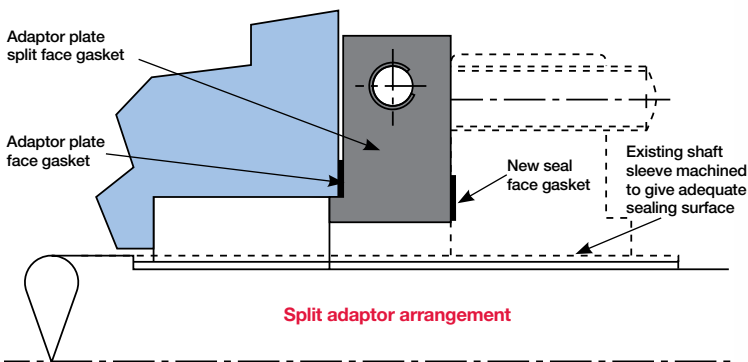

As part of the design objective, provision has been made for large cross section alternatives, for each shaft size, to minimize the need for adaptor plates. All large cross section radially divided seals will be produced to order from inventoried castings.

Stationary Seal

The RDS™ seal is a stationary seal. In a stationary seal the rotating member is fixed to the shaft and has no springs. The stationary member is spring-loaded, which is an effective way of overcoming potential angular mis-alignment problems. In addition very large clearances have been provided between the rotary and stationary members and the gland halves, which should minimize dead-ending or solidification problems that could be present in a stationary seal that had minimal clearances, particularly around the outside diameter of the stationary.

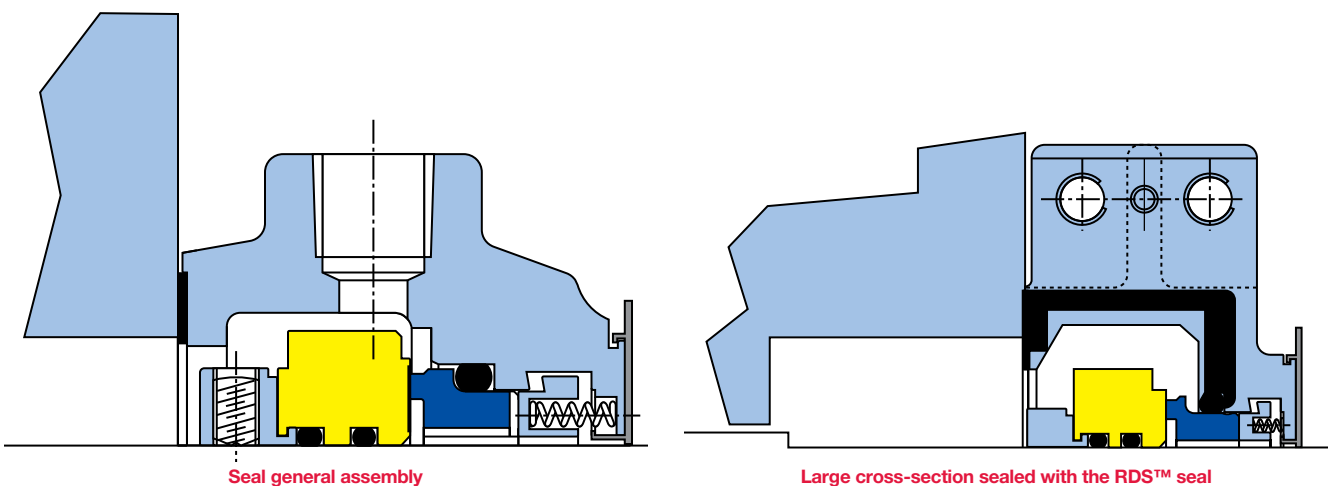

Performance

Extensive in-house testing has enabled us to set the following performance parameters.

The PV (Pressure x Velocity) capability of the seal is rated at 80 bar meters per second, which is 230,000 pounds per square inch / feet per minute.

Actual tests have been successfully completed at PV ratings of 340,000 pounds per square inch / feet per minute (120 bar meters per second) with a reduced life expectancy.

A chart follows which shows typical PV values, at a range of pressures, shaft diameters and at two different rotating speeds.

Calculated PV Factors				
Shaft Size	Pressure (bar/psi)	Speed (rpm)	Factor (bar m/s)	Factor (psi ft/min)
1.000 (25mm)	4/60	1450	7.7	22000
	10/150	1450	19.3	55000
	4/60	2850	15.1	43000
	10/150	2850	37.9	108000
1.000 (25mm)	4/60	1450	15.4	44000
	10/150	1450	38.6	110000
	4/60	2850	30.2	86000
2.000 (50mm)	10/150	2850	75.8	216000
	4/60	1450	23.1	66000
	10/150	1450	57.9	165000
4.000 (100mm)	4/60	2850	45.3	129000
	4/60	1450	30.3	86000
	10/150	1450	77.2	220000
5.000 (125mm)	4 /60	2850	60.4	172000
	4/60	1450	38.5	110000
	8/120	1450	77.2	220000
	4/60	2850	75.5	216000
5.000+ (125mm+)	Consult AESSEAL [®] (Maximum is 80 bar m/s (230,000 psi ft/min))			

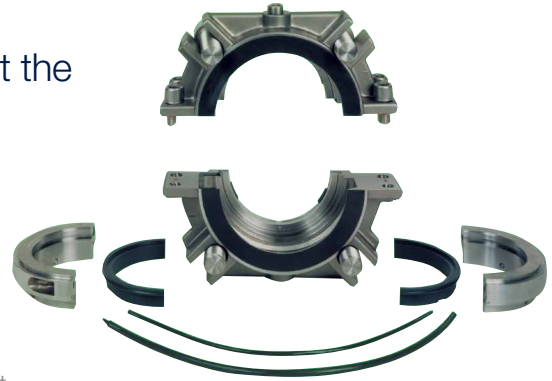

Design Concept

The most important single objective was to design a radially divided seal that was easy to install. This was achieved by having the smallest possible number of parts to assemble.

The entire seal assembly comprises of only three 'O' rings, two rotary halves, two stationary halves and two gland cartridge halves, which include the springs and spring retainer. The only other parts are socket set screws and Allen keys.

A pre-assembled patented spring retainer ensures the springs are not under compression during the initial assembly. All seal parts are assembled, fixed to the shaft and tightened, before loading the springs, which are only compressed when the seal assembly is bolted to the face of the stuffing box.

The elastomer seals for both the rotary face and gland assembly have been designed to simplify installation.

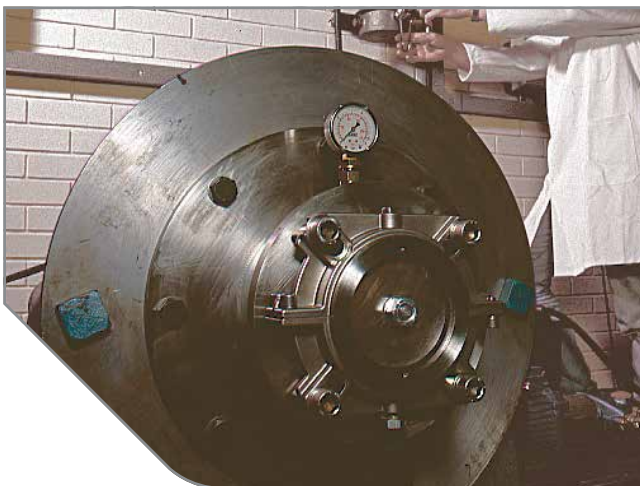

Dynamic test rig with 5.000" (125mm) RDS™ installed

Application Area

As with all radially divided seals, the ideal application area is in cool, clean fluids, which are non-hazardous and with minimal corrosive potential.

Such applications exist within every industry even though the RDS™ seal is not suitable for sealing even a majority of applications in most plants.

Where no emissions or leakage, even on an occasional basis, can be tolerated, our radially divided mechanical seal should not be installed.



RDS™ face testing equipment



Installation and Wear Indicator

A stationary anti-rotation pin is also designed as an indicator that the RDS™ seal has been properly installed, before pressurising and running the equipment.

An undercut in the pin should fall equally in the seal setting groove, if the seal is fitted to the correct working length.

The end of the pin will also move progressively towards the RDS™ gland as wear takes place, providing an indication of the remaining seal life. When the end of the pin is level with the gland, the RDS™ seal face replacement kit should be installed.

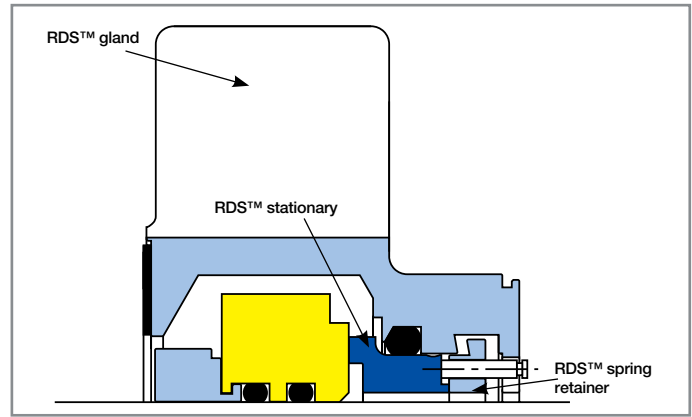

RDS™ seal anti rotation setting and wear indicator pin arrangement

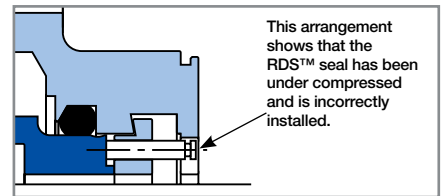
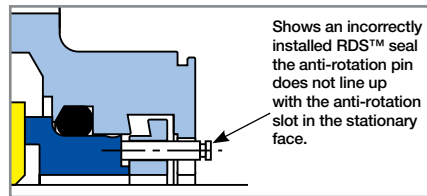
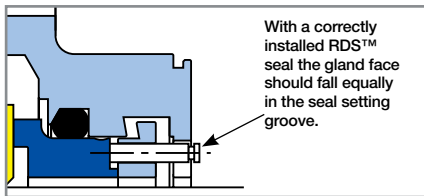

Gland Half Location and Bolting Detail

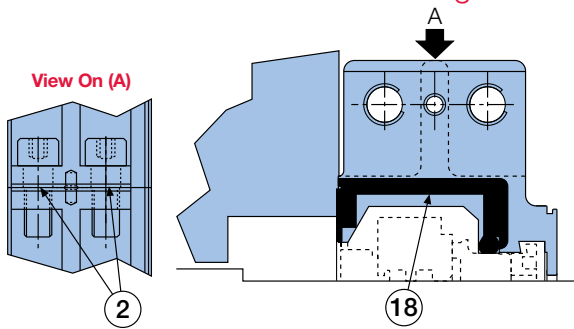

Gland Bolting Detail

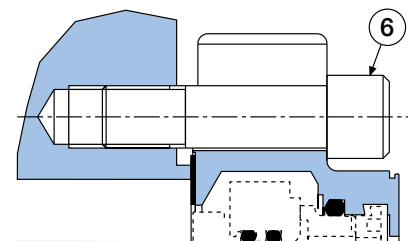

Seal General Assembly

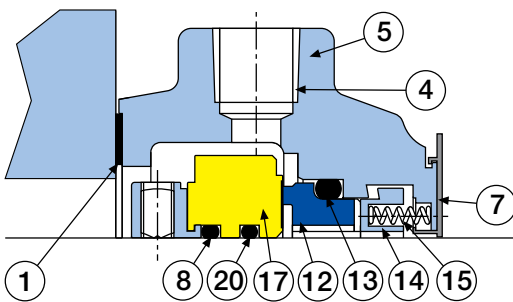

Item	Description	Material	Item	Description	Material
1	Gasket	Viton® / Aflas®*	11	Rotary Cap Head	316 Stainless Steel
2	Cap Head Screws	316 Stainless Steel	12	Stationary Face	Carbon
3	Gland Dowels	316 Stainless Steel	13	Stationary O Ring	Viton® / Aflas®*
4	Flush Port	n/a	14	Spring Retainer	316L SS
5	RDS™ Gland	316 Stainless Steel	15	Springs	Hastelloy® C
6	Gland Bolt	Not Supplied	16	Anti Rotation Pin	316 Stainless Steel
7	Centring Clips	Plastic	17	Solid Rotary Face	316L SS/CH.Ox
8	Shaft O Ring	Viton® / Aflas®*	18	Gland U-Gasket	Viton® / Aflas®*
9	Drive Screw	316 Stainless Steel	19	Rotary Face Clip	Plastic
10	Rotary Dowel	316 Stainless Steel	20	Shaft O Ring	Viton® / Aflas®*

* Aflas® is only available up to and including 8,000" (200mm).

RDS™ – Dimensional Information

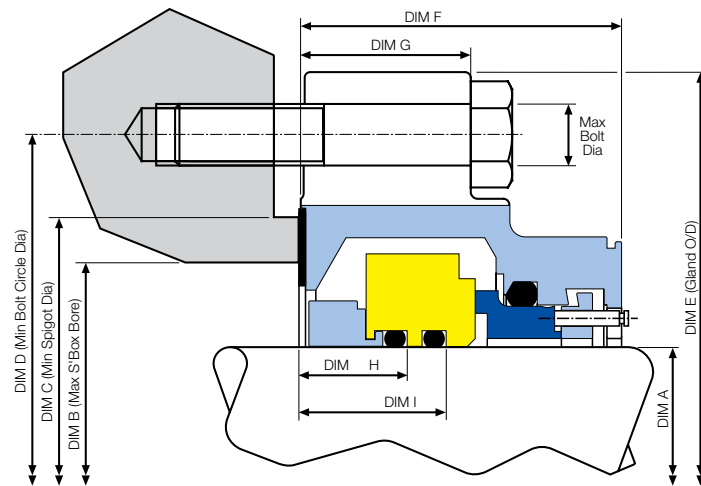

RDS™ – Dimensional Information (inches)

2.500" - 2.625" RDS™ seal from -21 casting

DIM A	DIM B	DIM C	DIM D	DIM E	DIM F	DIM G	DIM H	DIM I	Max Bolt Dia
2.500	3.750	4.250	5.125	6.500	1.938	1.750	0.818	1.120	0.625
2.625	3.750	4.250	5.125	6.500	1.938	1.750	0.818	1.120	0.625

2.625" - 2.750" RDS™ seal from -22 casting

2.625	4.250	4.750	5.687	7.750	2.500	1.750	0.818	1.120	0.625
2.750	4.250	4.750	5.687	7.750	2.500	1.750	0.818	1.120	0.625

2.500" - 3.000" RDS™ seal from -24/21 casting

2.500									
to	4.500	5.000	5.937	8.000	2.500	1.750	0.818	1.120	0.625 *
2.750									
2.875	4.500	5.000	5.937	8.000	2.500	1.750	0.818	1.120	0.625
3.000	4.500	5.000	5.937	8.000	2.500	1.750	0.818	1.120	0.625

2.500" - 3.250" RDS™ seal from -26/20 casting

2.500									
to	4.750	5.250	6.250	8.250	2.500	1.750	0.818	1.120	0.625 *
3.000									
3.125	4.750	5.250	6.250	8.250	2.500	1.750	0.818	1.120	0.625
3.250	4.750	5.250	6.250	8.250	2.500	1.750	0.818	1.120	0.625

2.625" - 3.500" RDS™ seal from -28/22 casting

2.625									
to	5.000	5.500	6.562	8.500	2.500	1.750	0.818	1.120	0.750 *
3.250									
3.375	5.000	5.500	6.562	8.500	2.500	1.750	0.818	1.120	0.750
3.500	5.000	5.500	6.562	8.500	2.500	1.750	0.818	1.120	0.750

2.875" - 3.750" RDS™ seal from -30/24 casting

2.875									
to	5.250	5.750	6.750	8.750	2.500	1.750	0.818	1.120	0.750 *
3.500									
3.625	5.250	5.750	6.750	8.750	2.500	1.750	0.818	1.120	0.750
3.750	5.250	5.750	6.750	8.750	2.500	1.750	0.818	1.120	0.750

3.125" - 4.000" RDS™ seal from -32/26 casting

3.125									
to	5.500	6.000	7.062	9.000	2.500	1.750	0.818	1.120	0.750 *
3.750									
3.875	5.500	6.000	7.062	9.000	2.500	1.750	0.818	1.120	0.750
4.000	5.500	6.000	7.062	9.000	2.500	1.750	0.818	1.120	0.750

3.625" - 4.500" RDS™ seal from -36/30 casting

3.625									
to	6.000	6.500	7.562	9.500	2.500	1.750	0.818	1.120	0.750 *
4.250									
4.375	6.000	6.500	7.562	9.500	2.500	1.750	0.818	1.120	0.750
4.500	6.000	6.500	7.562	9.500	2.500	1.750	0.818	1.120	0.750

RDS™ – Dimensional Information (mm)

63mm - 65mm RDS™ seal from -21 casting

DIM A	DIM B	DIM C	DIM D	DIM E	DIM F	DIM G	DIM H	DIM I	Max Bolt Dia
63.0	95.3	108.0	130.2	165.1	49.3	44.5	20.7	28.4	16.0 *
65.0	95.3	108.0	130.2	165.1	49.3	44.5	20.7	28.4	16.0 *

65mm - 70mm RDS™ seal from -22 casting

65	108.0	120.7	144.4	196.9	63.5	44.5	20.7	28.4	16.0
70	108.0	120.7	144.4	196.9	63.5	44.5	20.7	28.4	16.0

65mm - 75mm RDS™ seal from -24/21 casting

65	114.3	127.0	150.8	203.2	63.5	44.5	20.7	28.4	16.0 *
70	114.3	127.0	150.8	203.2	63.5	44.5	20.7	28.4	16.0 *
75	114.3	127.0	150.8	203.2	63.5	44.5	20.7	28.4	16.0

65mm - 80mm RDS™ seal from -26/20 casting

65									
to	120.7	133.4	158.8	209.6	63.5	44.5	20.7	28.4	16.0 *
75									
80	120.7	133.4	158.8	209.6	63.5	44.5	20.7	28.4	16.0

65mm - 85mm RDS™ seal from -28/22 casting

65									
to	127.0	139.7	166.7	215.9	63.5	44.5	20.7	28.4	20.0 *
80									
85	127.0	139.7	166.7	215.9	63.5	44.5	20.7	28.4	20.0

75mm - 95mm RDS™ seal from -30/24 casting

75									
to	133.4	146.1	171.5	222.3	63.5	44.5	20.7	28.4	20.0 *
85									
90	133.4	146.1	171.5	222.3	63.5	44.5	20.7	28.4	20.0
95	133.4	146.1	171.5	222.3	63.5	44.5	20.7	28.4	20.0

80mm - 100mm RDS™ seal from -32/26 casting

80									
to	139.7	152.4	179.4	228.6	63.5	44.5	20.7	28.4	20.0 *
95									
100	139.7	152.4	179.4	228.6	63.5	44.5	20.7	28.4	20.0

90mm - 110mm RDS™ seal from -36/30 casting

90									
to	152.4	165.1	192.1	241.3	63.5	44.5	20.7	28.4	20.0 *
105									
110	152.4	165.1	192.1	241.3	63.5	44.5	20.7	28.4	20.0

RDS™ – Dimensional Information (inches)

4.125" - 5.125" RDS™ seal from -40/34 casting

DIM A	DIM B	DIM C	DIM D	DIM E	DIM F	DIM G	DIM H	DIM I	Max Bolt Dia
4.125									
to	6.500	7.000	8.062	11.000	2.500	1.750	0.818	1.120	0.750 *
4.750									
4.875	6.500	7.000	8.062	11.000	2.500	1.750	0.818	1.120	0.750
5.000	6.500	7.000	8.062	11.000	2.500	1.750	0.818	1.120	0.750
5.125	6.500	7.000	8.062	11.000	2.500	1.750	1.025	1.397	0.750 *

5.250" - 5.500" RDS™ seal from -44 casting

5.250	7.500	8.000	9.000	11.750	3.187	2.375	1.025	1.397	1.000
5.500	7.500	8.000	9.000	11.750	3.187	2.375	1.025	1.397	1.000

5.750" - 6.000" RDS™ seal from -48 casting

5.750	8.000	8.500	9.500	12.250	3.187	2.375	1.025	1.397	1.000
6.000	8.000	8.500	9.500	12.250	3.187	2.375	1.025	1.397	1.000

6.250" - 6.500" RDS™ seal from -52 casting

6.250	8.500	9.000	9.875	12.750	3.187	2.375	1.025	1.397	1.000
6.500	8.500	9.000	9.875	12.750	3.187	2.375	1.025	1.397	1.000

6.750" - 7.000" RDS™ seal from -56 casting

6.750	9.000	9.500	10.500	13.250	3.437	2.625	1.025	1.397	1.000
7.000	9.000	9.500	10.500	13.250	3.437	2.625	1.091	1.647	1.000

7.250" - 7.500" RDS™ seal from -60 casting

7.250	9.500	10.000	11.000	13.750	3.437	2.625	1.091	1.647	1.000
7.500	9.500	10.000	11.000	13.750	3.437	2.625	1.091	1.647	1.000

7.750" - 8.000" RDS™ seal from -64 casting

7.750	10.250	11.000	12.250	16.000	3.660	3.187	1.091	1.647	1.000
8.000	10.250	11.000	12.250	16.000	3.660	3.187	1.091	1.647	1.000

8.250" - 8.500" RDS™ seal from -68 casting

8.250	10.750	11.500	12.750	16.500	3.660	3.187	1.287	1.711	1.000
8.500	10.750	11.500	12.750	16.500	3.660	3.187	1.287	1.711	1.000

8.750" - 9.000" RDS™ seal from -72 casting

8.750	11.250	12.000	13.250	17.000	3.660	3.187	1.287	1.711	1.000
9.000	11.250	12.000	13.250	17.000	3.660	3.187	1.287	1.711	1.000

9.250" - 9.500" RDS™ seal from -76 casting

9.250	11.750	12.500	13.750	17.500	3.660	3.187	1.287	1.711	1.000
9.500	11.750	12.500	13.750	17.500	3.660	3.187	1.287	1.711	1.000

9.625" - 10.000" RDS™ seal from -80 casting

9.625	12.250	13.000	14.250	18.000	3.875	3.187	1.287	1.711	1.000
9.750	12.250	13.000	14.250	18.000	3.875	3.187	1.287	1.711	1.000
10.000	12.250	13.000	14.250	18.000	3.875	3.187	1.287	1.711	1.000

10.250" - 10.500" RDS™ seal from -84 casting

10.250	12.750	13.500	14.750	18.500	3.875	3.187	1.287	1.711	1.000
10.500	12.750	13.500	14.750	18.500	3.875	3.187	1.287	1.711	1.000

10.750" - 11.000" RDS™ seal from -88 casting

10.750	13.250	14.000	15.250	19.000	3.875	3.187	1.287	1.711	1.000
11.000	13.250	14.000	15.250	19.000	3.875	3.187	1.287	1.711	1.000

11.250" - 11.500" RDS™ seal from -92 casting

11.250	13.750	14.500	15.750	19.500	3.875	3.187	1.287	1.711	1.000
11.500	13.750	14.500	15.750	19.500	3.875	3.187	1.287	1.711	1.000

11.750" - 12.000" RDS™ seal from -96 casting

11.750	14.250	15.000	16.250	20.000	3.875	3.187	1.287	1.711	1.000
12.000	14.250	15.000	16.250	20.000	3.875	3.187	1.287	1.711	1.000

* signifies glands machined to order, all others are planned inventory items

WARNING - Maximum P.V. rating is 80 bar m/s (230,000 psi ft/min)

Not all sizes inventoried consult AESSEAL® for availability. For details on sizes not shown contact AESSEAL®

RDS™ – Dimensional Information (mm)

105mm - 130mm RDS™ seal from -40/34 casting

DIM A	DIM B	DIM C	DIM D	DIM E	DIM F	DIM G	DIM H	DIM I	Max Bolt Dia
105									
to	165.1	177.8	204.8	279.4	63.5	44.5	20.7	28.4	20.0 *
120									
125	165.1	177.8	204.8	279.4	63.5	44.5	20.7	28.4	20.0
130	165.1	177.8	204.8	279.4	63.5	44.5	26.0	35.5	20.0

140mm - RDS™ seal from -44 casting

140.0	190.5	203.2	228.6	298.4	80.9	60.3	26.0	35.5	25.0
-------	-------	-------	-------	-------	------	------	------	------	------

145mm - 150mm RDS™ seal from -48 casting

145.0	203.2	215.9	241.3	311.1	80.9	60.3	26.0	35.5	25.0
150.0	203.2	215.9	241.3	311.1	80.9	60.3	26.0	35.5	25.0

160mm - 165mm RDS™ seal from -52 casting

160.0	215.9	228.6	254.0	323.8	80.9	60.3	26.0	35.5	25.0
165.0	215.9	228.6	254.0	323.8	80.9	60.3	26.0	35.5	25.0

170mm - 175mm RDS™ seal from -56 casting

170.0	228.6	241.3	266.7	336.5	87.3	66.7	26.0	35.5	25.0
175.0	228.6	241.3	266.7	336.5	87.3	66.7	26.0	35.5	25.0

180mm - 190mm RDS™ seal from -60 casting

180.0	241.3	254.0	279.4	349.2	87.3	66.7	27.7	41.8	25.0
190.0	241.3	254.0	279.4	349.2	87.3	66.7	27.7	41.8	25.0

200mm - 205mm RDS™ seal from -64 casting

200	260.4	275.4	311.2	406.4	93.0	81.0	27.7	41.8	24.0
205	260.4	275.4	311.2	406.4	93.0	81.0	32.7	43.5	24.0

210mm - 215mm RDS™ seal from -68 casting

210	273.0	292.1	323.9	419.1	93.0	81.0	32.7	43.5	24.0
215	273.0	292.1	323.9	419.1	93.0	81.0	32.7	43.5	24.0

220mm - 225mm RDS™ seal from -72 casting

220	285.8	304.8	336.6	431.8	93.0	81.0	32.7	43.5	24.0
225	285.8	304.8	336.6	431.8	93.0	81.0	32.7	43.5	24.0

230mm - 240mm RDS™ seal from -76 casting

230	298.5	317.5	349.3	444.5	93.0	81.0	32.7	43.5	24.0
240	298.5	317.5	349.3	444.5	93.0	81.0	32.7	43.5	24.0

245mm - 255mm RDS™ seal from -80 casting

245	311	330.2	361.9	457.2	98.4	81.0	32.7	43.5	24.0
250	311	330.2	361.9	457.2	98.4	81.0	32.7	43.5	24.0
255	311	330.2	361.9	457.2	98.4	81.0	32.7	43.5	24.0

260mm - 265mm RDS™ seal from -84 casting

260	323.8	342.9	374.6	469.9	98.4	81.0	32.7	43.5	24.0
265	323.8	342.9	374.6	469.9	98.4	81.0	32.7	43.5	24.0

270mm - 280mm RDS™ seal from -88 casting

270	336.5	355.6	387.3	482.6	98.4	81.0	32.7	43.5	24.0
280	336.5	355.6	387.3	482.6	98.4	81.0	32.7	43.5	24.0

285mm - 290mm RDS™ seal from -92 casting

285	349.2	368.3	400.0	495.3	98.4	81.0	32.7	43.5	24.0
290	349.2	368.3	400.0	495.3	98.4	81.0	32.7	43.5	24.0

295mm - 305mm RDS™ seal from -96 casting

295	361.9	381.0	412.7	508.0	98.4	81.0	32.7	43.5	24.0
305	361.9	381.0	412.7	508.0	98.4	81.0	32.7	43.5	24.0

RDS™ Hard Face

Encompassing all the features and benefits of the RDS™ the RDS™ Hard Face has been specifically designed to seal non-hazardous applications in which Carbon / 316 Chrome Oxide faces are not recommended.

The design is fully interchangeable with the RDS™ giving the user complete flexibility and reduced inventory.

- Face combinations:
Stationary – Carbon / SiC
Rotary face – SiC
- Size range 2.500" - 5.000" (65mm - 125mm)

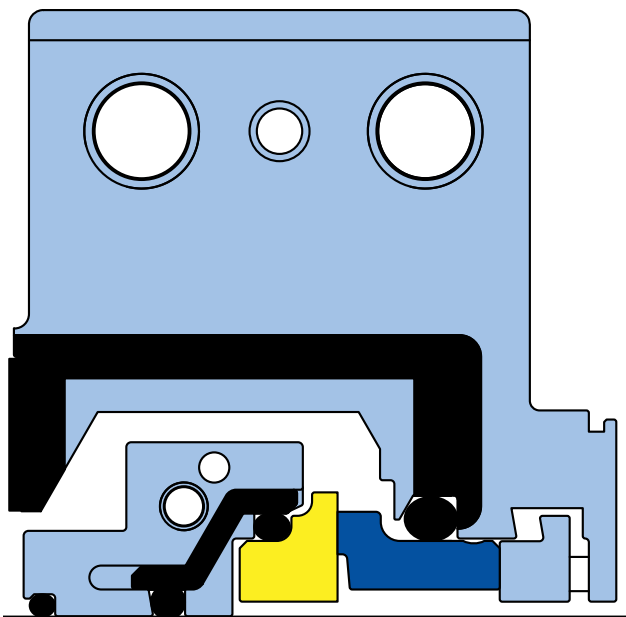
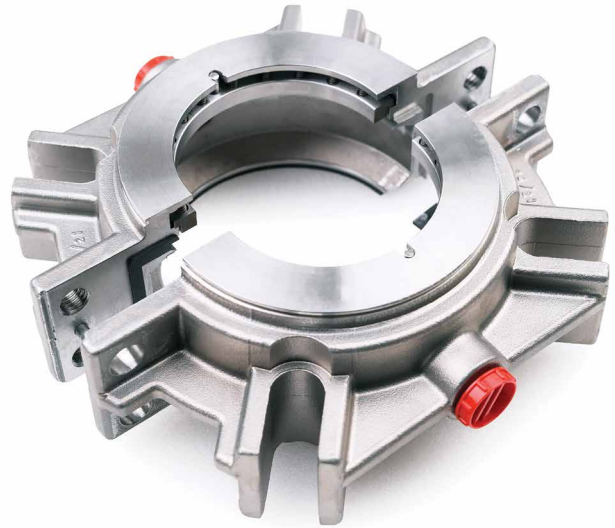

RDS™ Hard Face



SiC split faces

Not all sizes inventoried consult with AESSEAL® for availability.

For further information and safe operating limits contact our technical specialists at the locations below.



Use double mechanical seals with hazardous products.

Always take safety precautions:

- Guard your equipment
- Wear protective clothing



WARNING

UK Sales & Technical advice:

AESSEAL plc
Mill Close
Bradmarsh Business Park
Rotherham, S60 1BZ
United Kingdom

Tel: +44 (0) 1709 369966
Fax: +44 (0) 1709 720788
E-mail: seals@aes seal.com

Distributed by:

'Our purpose is to give our customers such exceptional service that they need never consider alternative sources of supply.'



USA Sales & Technical advice:

AESSEAL Inc.
355 Dunavant Drive
Rockford,
TN. 37853
USA

Tel: +1 865 531 0192
Fax: +1 865 531 0571
E-mail: usa@aes seal.com

Important: Since the conditions and methods of use of this product are beyond our control, AESSEAL plc expressly disclaims any and all liability resulting or arising from any use of this product or reliance on any information contained in this document - AESSEAL plc standard conditions of sale apply. All sizes are subject to manufacturing tolerances. We reserve the right to modify specifications at any time. AESSEAL® is a Registered Trademark of AESSEAL plc, AESSEAL plc recognizes all trademarks and trademark names as the property of their owners.