

LabTecta® 66IAP

LabTecta® 66OAP

Engineered Solutions with Positive Air Purge



- Eliminate the cause of over 50% of bearing failures with the LabTecta®66 range
- Designed to prevent contamination even in extreme environments
- Eliminate maintenance and wearing parts
- Maximize reliability with no heat generation, vibration or lubrication



LabTecta®66OAP - Outboard Air Purge

The LabTecta®66OAP is specifically designed for use in extreme environments and applications where contamination may completely cover the seal.

It will ensure that no contamination can enter the seal and the housing. The OAP uses a positive air purge to enhance the performance of the labyrinth. Its unique design utilizes mechanical seal pressure balancing technology to maximize the performance of the seal and minimize air consumption.

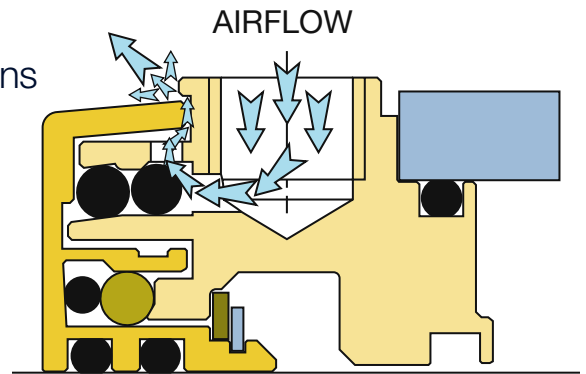

LabTecta®66IAP and LabTecta®66OAP

- Eliminate maintenance and wearing parts
- Prevent contamination across the seal
- Maximize reliability with no heat generation, vibration or lubrication

Installation Made Easy

Installation with either the IAP or OAP design is made easy by designing the seal to suit your specific equipment. AESSEAL® has multiple options including flange mount, pillowblock mount (shown below right) or a standard press in mount (shown above).

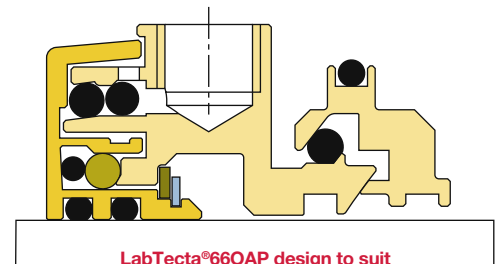

LabTecta®66OAP design to suit pillowblock applications.

Sealing applications covered with powder or slurry are challenging for any standard bearing seal.

The LabTecta®66OAP is specifically designed for this environment ensuring no contamination can enter the seal and compromise its performance.

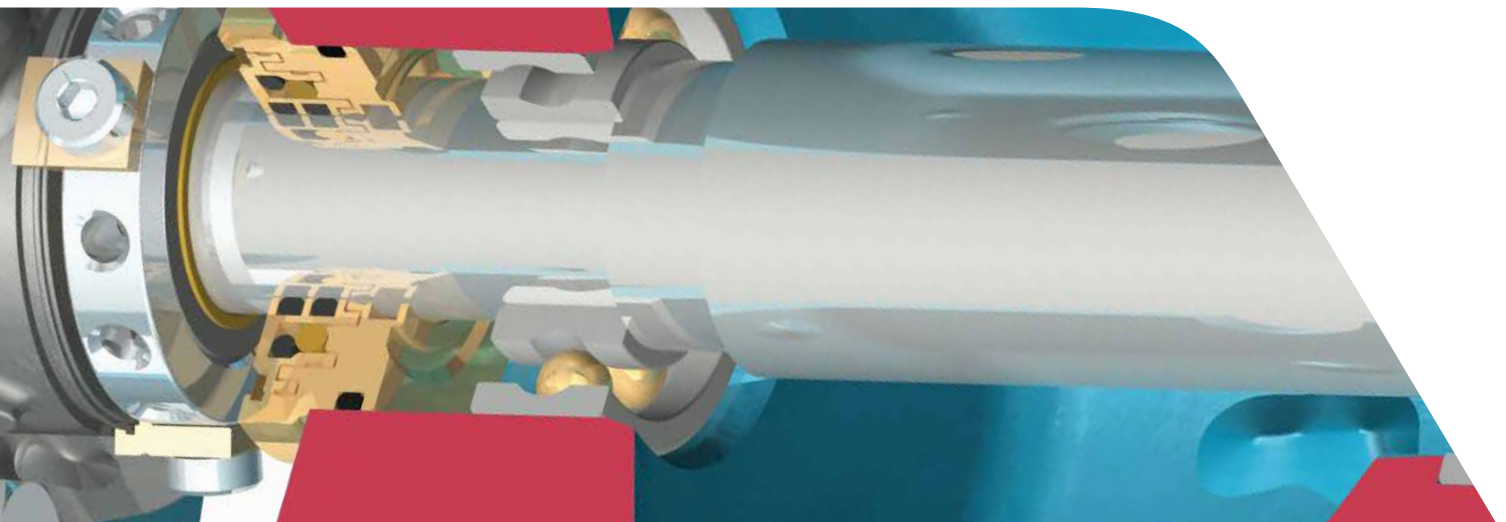



LabTecta®66IAP - Inboard Air Purge

The LabTecta®66IAP design is ideal for applications where it is necessary to retain product, gases or exhaust within an enclosure.

Common applications are fans, screw conveyors rotary valves and other powder handling equipment. The IAP uses labyrinth technology to direct the air purge inboard preventing the product being sealed from entering the seal and escaping to the environment.

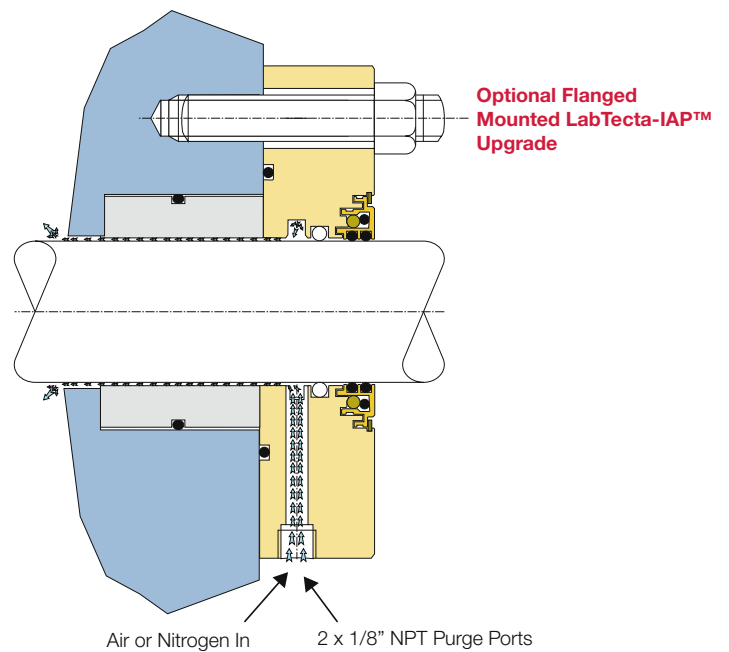
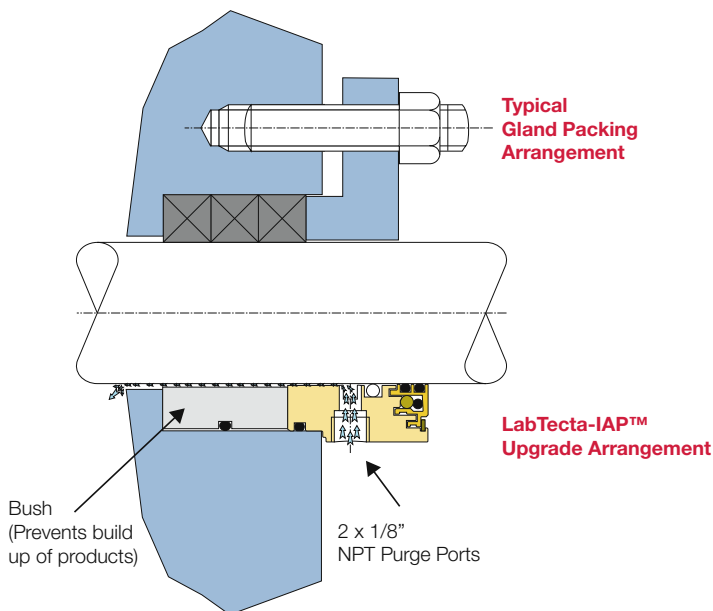
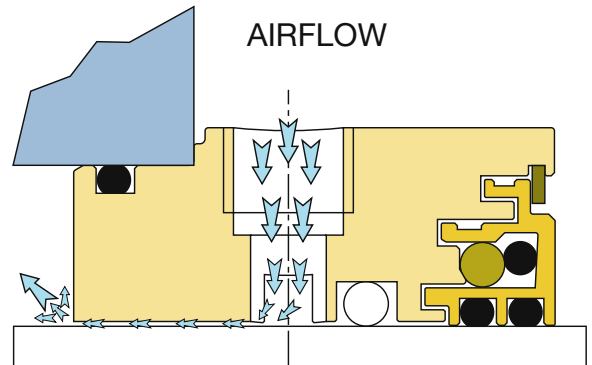

Sealing fan housings is made easy with the LabTecta®66IAP. The positive air purge will contain any emissions or contamination that tries to escape. With no contacting parts during operation, there is no vibration and no maintenance required.



Further information about the AESSEAL® LabTecta®66 range is available in the standard LabTecta®66 brochure. E-mail: sales@labtecta.com to request a copy or download it from our website: www.labtecta.com

LabTecta®66IAP & LabTecta®66OAP

Sketch Housing Dimensions

Either use the "standard" diagram provided or sketch your own below.

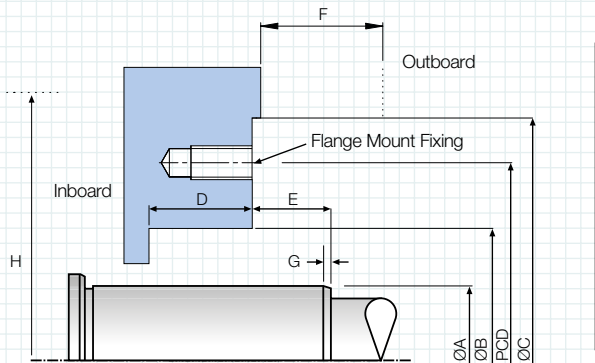

Dimensions

ØA (Shaft Ø):
 ØB (Housing Bore Ø):
 PCD (Pitch Circle Diameter):
 ØC (First Obstruction):
 D (Max. Insertion):
 E (Distance to Step):

F (First Obstruction):
 G (Chamfer Size):
 H (Product Height):
 Quantity of Holes:
 Bolt Size :
 Bolting Spacing :

Application Data:

Equipment Type:
 Shaft Speed:
 Lubrication Type / System:
 Product to be Sealed:
 Shaft: Horizontal Vertical Angle:
 Max. Axial Misalignment:
 Max. Radial Misalignment:

Seal Type: Split Solid
 Temperature at Seal Location :

A brief description of the application:

Complete the information above and send to: UK Fax: **+44 (0) 1709 720788** USA Fax: **+1 865 531 0571**
 E-mail: sales@labtecta.com

For further information and safe operating limits contact our technical specialists at the locations below.



Use double mechanical seals with hazardous products.

Always take safety precautions:

WARNING

- Guard your equipment
- Wear protective clothing

UK Sales & Technical advice:
 AESSEAL plc
 Mill Close
 Bradmarsh Business Park
 Rotherham, S60 1BZ
 United Kingdom
 Tel: +44 (0) 1709 369966
 Fax: +44 (0) 1709 720788
 E-mail: seals@aes seal.com

Distributed by:

'Our purpose is to give our customers such exceptional service that they need never consider alternative sources of supply.'

INVESTOR IN PEOPLE

USA Sales & Technical advice:
 AESSEAL Inc.
 355 Dunavant Drive
 Rockford,
 TN. 37853
 USA
 Tel: +1 865 531 0192
 Fax: +1 865 531 0571
 E-mail: usa@aes seal.com

Important: Since the conditions and methods of use of this product are beyond our control, AESSEAL plc expressly disclaims any and all liability resulting or arising from any use of this product or reliance on any information contained in this document - AESSEAL plc standard conditions of sale apply. All sizes are subject to manufacturing tolerances. We reserve the right to modify specifications at any time. AESSEAL® is a Registered Trademark of AESSEAL plc, AESSEAL plc recognizes all trademarks and trademark names as the property of their owners.